

harman kardon

MODEL T-10

The Overture

PRINTED CIRCUIT AM-FM TUNER

OPERATION AND SERVICE INSTRUCTIONS

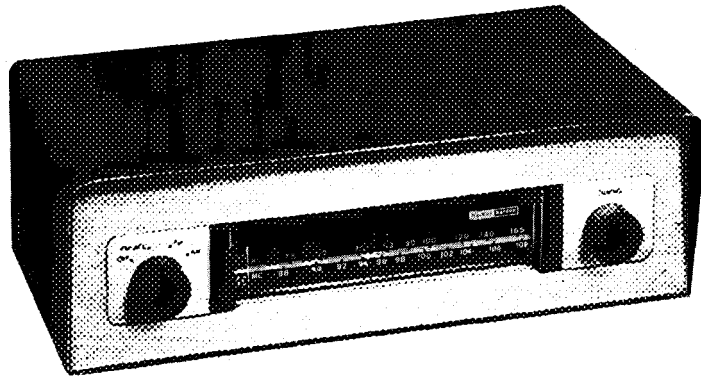

UNPACKING

After unpacking the Overture, inspect it carefully for any signs of damage in transit. Your unit was subjected to many inspections and tests, and then carefully packed. If any damage is visible, notify the transportation company at once.

Check the contents of the package carefully.

You should find:

- 1 Tuner, Model T-10
- 1 Instruction Booklet
- 1 Warranty Card

It is strongly urged that the warranty card be completed and mailed without delay, to protect your rights under the warranty. If you should require repair service or information on the use of the Overture, we will be able to identify your unit immediately, and respond quickly.

CONNECTIONS

AM ANTENNA

The Harman-Kardon ceramic loopstick, built into the Overture, comprises all the antenna required for

the finest in noise-free local AM reception. In locations more removed from metropolitan areas, an outdoor antenna may be required. This should consist of a single wire, as long as is reasonably practical, located away from large metal objects, power lines or electrical machinery. Connect one end to the AM terminal of the ANTENNA terminal strip on the rear of the chassis.

FM ANTENNA

A short length of ordinary wire, connected to the terminal marked FM will prove adequate in most installations. A loop of wire, approximately 36 inches long, connected between "FM" and "G" and hung inside the cabinet will prove useful in increasing the rejection of spurious signals. In those situations requiring an external FM antenna, connection should be made between "G" and "FM". A single dipole will be useful when stations to be received are located in opposite directions from each other. A non-directional dipole should be

HARMAN - KARDON, INC.

520 MAIN STREET, WESTBURY, L. I., N. Y.

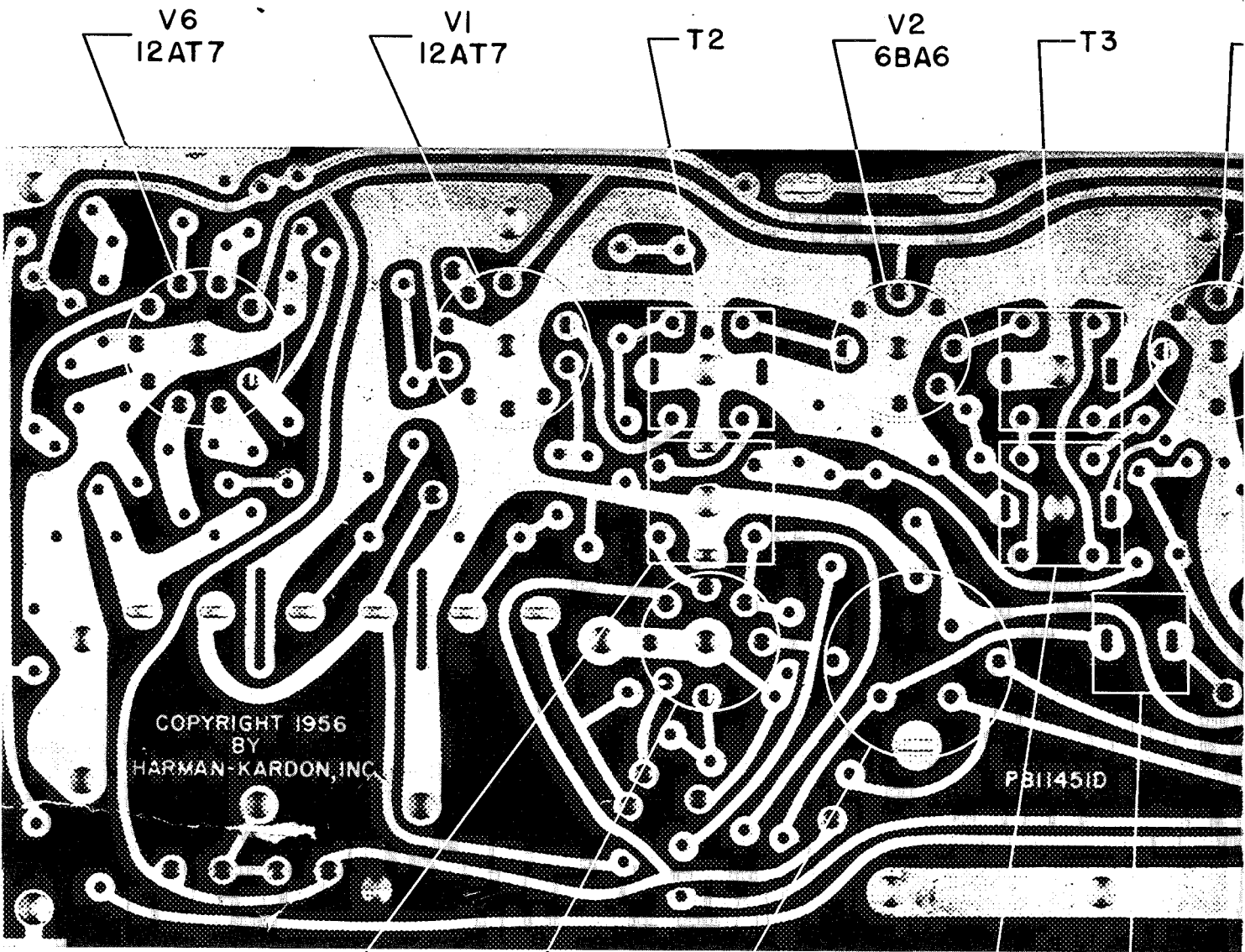

REPRODUCTION FORBIDDEN

T7 V7 6BE6 ELECTROLYTIC CAPACITOR T6 SELE RECT

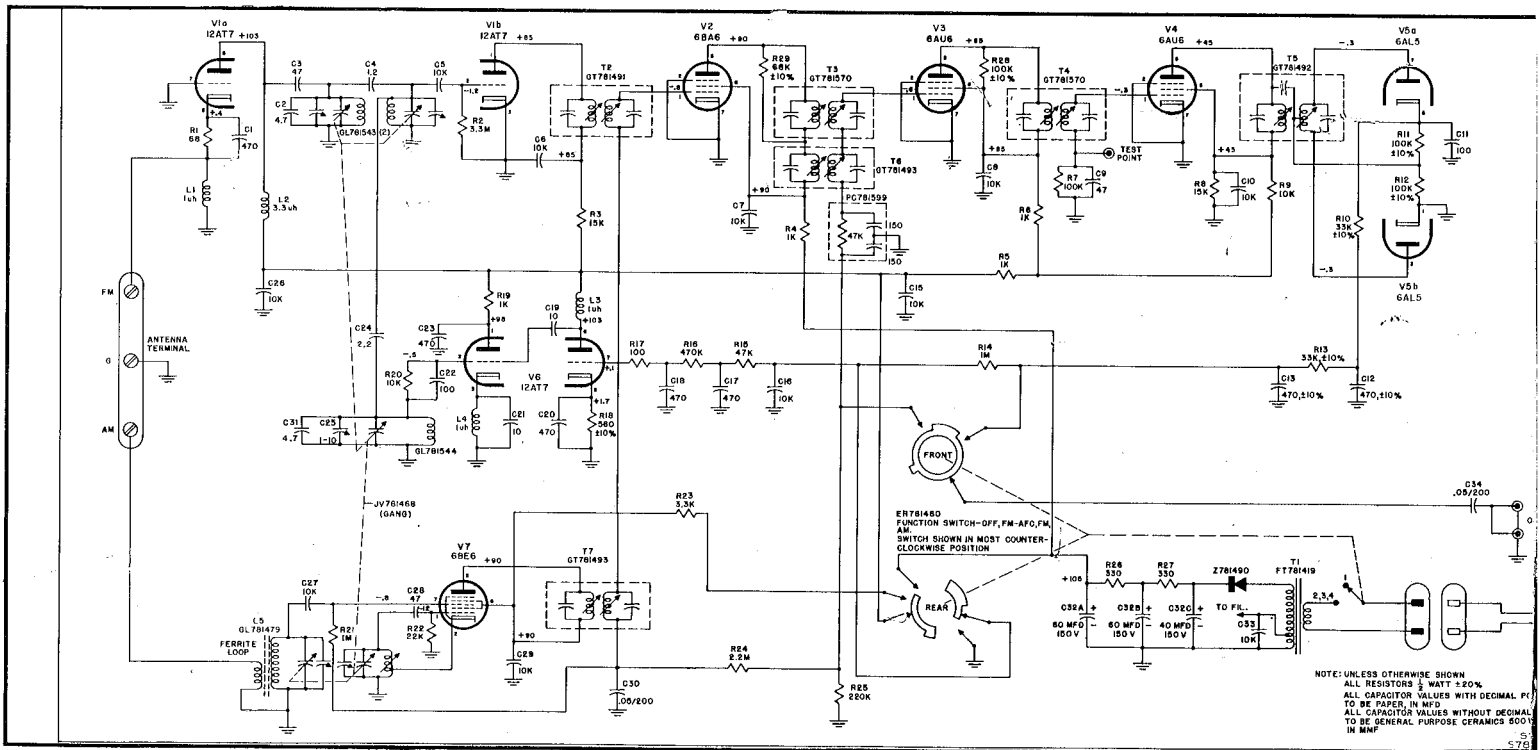

V3
6AU6

T4

V4
6AU6

MODEL T-10

CONSTRUCTION SHEET

The photograph at the left shows the printed circuit board used in this Harman-Kardon tuner and indicates to some degree the complexity of design and painstaking care required in the planning of such a circuit. FM frequencies, by their very nature, require careful placement of parts and leads. In conventional tuners using point to point wiring, misplacement of a wire, even a slight amount from its correct position will adversely affect operation.

We have designed this tuner to use a printed circuit board where each component and each connecting lead has been placed in a position affording best possible operation.

This form of design results, we feel, in providing a tuner with exceptional characteristics and reflects the highest state in the art of tuner construction.

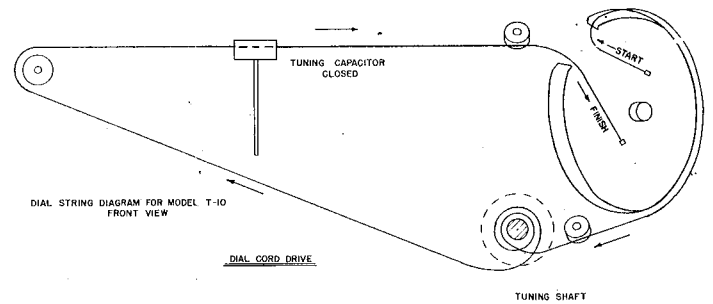
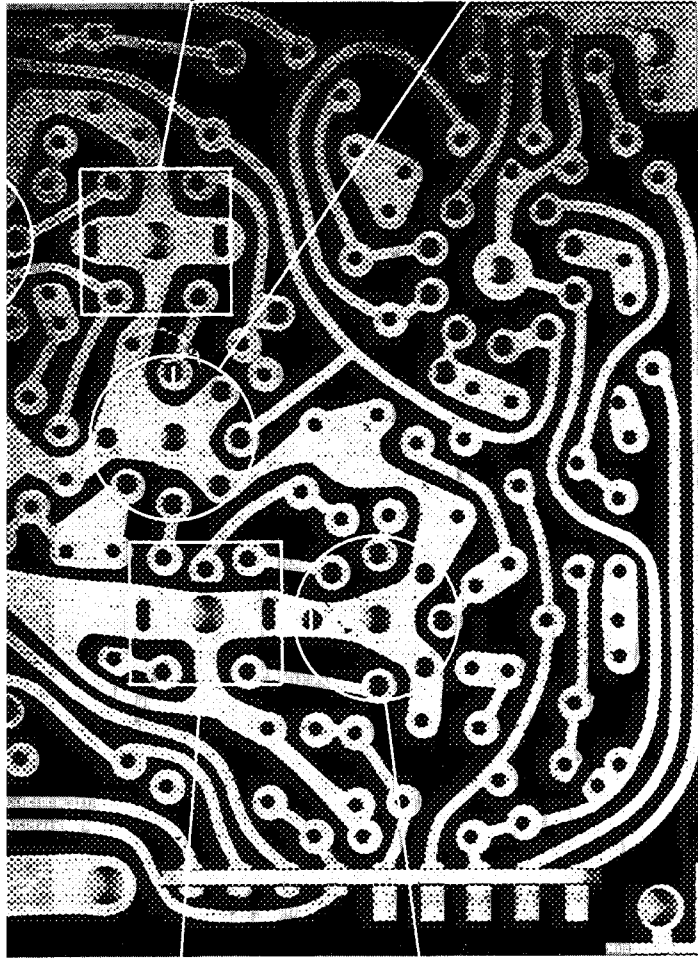

IIUM
FIER

T5

V5
6AL5

FUNCTION SWITCH SETTING	SIGNAL GENERATOR		SIGNAL INPUT POINT	OUTPUT INDICATOR	CONNECT INDICATOR TO:	DIAL SETTING	ADJUST	OUTPUT INDICATION
	FREQ.	MOD.						
AM	455 KC	30% AM	AM RF GANG	AC-VTVM OR SCOPE	TUNER OUTPUT	1600 KC	2 AM IF TRANS.	MAXIMUM OUTPUT
AM	1500 KC	30% AM	AM ANT. TERM.	AC-VTVM OR SCOPE	TUNER OUTPUT	1500 KC	OSC & ANT TRIMMERS	MAXIMUM OUTPUT
AM	600 KC	30% AM	AM ANT. TERM.	AC-VTVM OR SCOPE	TUNER OUTPUT	600 KC	OSC COIL & LOOPSTICK	MAXIMUM OUTPUT
AM	1500 KC							REPEAT STEP 2

AM ALIGNMENT PROCEDURE

FUNCTION SWITCH SETTING	SIGNAL GENERATOR		SIGNAL INPUT POINT	OUTPUT INDICATOR	CONNECT INDICATOR TO:	DIAL SETTING	ADJUST	OUTPUT INDICATION
	FREQ.	MOD.						
FM	10.7 MC	300KC FM 60 CPS	FM MIXER GANG	AC-VTVM OR SCOPE	TEST POINT	—	3 FM IF TRANS.	MAX GAIN & SYMMETRY
FM	10.7 MC	300KC FM 60 CPS	FM MIXER GANG	AC-VTVM OR SCOPE	TUNER OUTPUT	—	DISCR. TRANS.	S PATTERN OF MAX GAIN & SYMM.
FM	106 MC	300KC FM 60 CPS	FM ANT. TERMINAL	AC-VTVM OR SCOPE	TEST POINT	106 MC	106 MC OSC RF, MIXER TRIMMERS	MAXIMUM OUTPUT
FM	90 MC	300KC FM 60 CPS	FM ANT. TERMINAL	AC-VTVM OR SCOPE	TEST POINT	90 MC	OSC, RF, MIXER COILS	MAXIMUM OUTPUT

FM ALIGNMENT PROCEDURE

SERVICE NOTES

Servicing printed circuits is a simple matter and is more complicated than servicing conventionally wired circuits.

Printed circuit receivers, can be more easily repaired, if certain precautions are observed. Standard components are used throughout and can be removed and replaced by any serviceman. No special tools or skills are necessary. However, some parts which have special mounting and connection lugs should be replaced with exact duplicate parts.

VOID DAMAGE TO COPPER FOIL

Be careful when removing components from the board. However, if the copper foil wiring is damaged a piece of wire can be used to replace the damaged foil. Small breaks can be "jumped" with molten solder. Larger breaks can be repaired with ordinary hook up wire. It is unnecessary to replace the entire board because of foil breakage.

VOID DAMAGE TO PRINTED CIRCUIT BOARD

Do not apply excessive pressure to the printed circuit board or components. This is especially important to note when changing tubes. Although the board is sturdy in construction and mounting, it may crack or break if proper care is not taken when servicing. In case the board is to be removed from the chassis, remove the mounting screws around the edges and unhold the few leads that connect between the board and the chassis. If this is done, a vise with protected jaws could be used to hold the board while servicing and care should be taken not to exert excessive pressure against the board.

VOID EXCESSIVE DEPOSITS OF SOLDER

In some areas on the printed circuit board, the wiring is very closely spaced. When resoldering a new component avoid excessive deposits of solder. Excessive solder may cause a short or an intermittent trouble to occur later which may be difficult to locate.

VOID OVERHEATING

When using the soldering iron (35 watts or less), do not overheat the component terminals or the copper foil. Excessive heat (applying soldering iron longer than necessary, using a higher wattage soldering iron than recommended, or using a solder gun) may cause the bond between the board and foil to break. This will necessitate replacement or repair of the foil connection.

TOOLS AND MATERIALS REQUIRED

- Low wattage soldering iron with a small point or wedge (rating should not exceed 35 watts).
- Small wire brush.

- (3) 60% tin, 40% lead, low temperature rosin core solder.
- (4) Thin bladed knife.
- (5) Small wire pick, or soldering aid.

REPLACING COMPONENTS

SOLDERING REPLACEMENT COMPONENT TO OLD LEADS

Cut the leads where they enter the defective component. Clean off the ends of the leads, leaving as much of the leads as possible. Make a small loop in each lead of the replacement component and slide the loops over the remaining leads of the old component. Caution should be taken not to overheat the connection since the copper foil may peel or the original component lead may fall out of the board. This is possible due to heat transfer through the leads. The lead length of the replacement part should be kept reasonably short to provide some mechanical rigidity.

UNSOLDERING AND RESOLDERING COMPONENTS

To test a component or if the component is mounted in such a manner that the above method can not be used (such as vertically mounted capacitors, etc.) the component can be replaced by unsoldering it. This procedure should be used whenever it is necessary to unsolder any connections to replace defective components.

(a) Heat the connection on the wiring side of the board with a small soldering iron. When the solder melts, brush away the solder. Do not overheat the connection. In the process of removing the solder, caution must be taken to prevent excessive heating. Therefore, do not leave the iron on the connection while brushing away the solder. Melt the solder, remove the iron and quickly brush away the solder. It may require more than one heating and brushing process to completely remove the solder.

(b) Insert a knife blade between the wiring foil and the "bent-over" component lead and bend the lead perpendicular to the board. (It may be necessary to apply the soldering iron to the connection while performing this step as it is sometimes difficult to completely break the connection by brushing.) Do not overheat the connection.

(c) While applying the soldering iron to the connections, "wiggle" the component until it is removed.

(d) Remove any small particles of solder using a clean cloth dipped in solvent.

(e) A thin film of solder may remain over the hole through the board after removing the component. Pierce the film with the lead from the new component after heating the solder film with the soldering iron.

(f) Insert the leads of the new component through the holes provided. Cut to desired length and bend over the ends against the copper foil. Resolder the connection with 60/40 low temperature solder.

used if the stations are located in dispersed directions. A folded dipole antenna with reflector will provide maximum efficiency and may increase the number of distant FM stations your T-10 can receive.

POWER

Plug the power cord into any outlet furnishing 117 volts, 60 cycles house current. The exact voltage is relatively unimportant, and may vary between 105 and 125. Be sure, however, that you have 60 cycle AC power. For many installations, such as with the Prelude Model PC-200 Amplifier, it will be more convenient, from an operational point of view, to plug the power cord of the Overture into the convenience outlets provided on the amplifier chassis. The tuner will then be turned on or off by the amplifier power switch.

OUTPUT

A receptacle, marked "OUTPUT" will be found at the rear of the chassis. A shielded cable of the shortest practical length, which may be purchased at any electronic supply store, should be used to connect from this receptacle to the tuner input receptacle on the amplifier.

VENTILATION

All electrical equipment generates heat which must be allowed to escape. Although the Overture is well ventilated in itself, sufficient space should be allowed around it to permit free air flow. If it is placed in a bookcase, it should be located well toward the front, to provide as much clearance as possible at the rear.

Do not put books or other objects on top of the Overture. This would reduce the ventilation and result in sharply reduced component and tube life.

OPERATION

CONTROLS

The Harman-Kardon Overture has only two operating controls. The Function Switch (at the left) serves to turn the power off in its extreme counterclockwise position. In any other position the power is turned on. This switch consecutively selects FM with AFC, FM without AFC and AM. The Tuning Knob (at the right) is used to tune to the desired station.

AUTOMATIC FREQUENCY CONTROL (AFC)

FM Broadcasting, by its very nature, eliminates almost all natural and man-made static. However, the characteristics of FM which make this possible also

make for problems in tuning. The HARMAN-KARDON Overture incorporates an effective Automatic Frequency Control (AFC) circuit that overcomes these problems and insures proper tuning even if the manual tuning is not accurately done. The following experiment will lead to an understanding of AFC, and the fuller enjoyment of the Overture.

Tune across the FM scale with the function switch in the FM-AFC position. Note how the stations "pop" into place. Now tune to any station, preferably one with a musical program. Defeat the AFC by turning the function switch to the FM position, and tune slowly through the station from left to right. Notice that there are three points where the station sounds clean, interspersed with points of distorted sound. The middle clean-sounding point is the proper tuning position for the best tone quality with minimum noise and interference. Detune the station so that the sound is distorted. Turn the function switch to FM-AFC, and notice how the sound clears up.

Actually, the tuning has been readjusted by the operation of the AFC circuit, which automatically retunes the electronic circuits to the center of the station channel.

The AFC circuit of the Harman-Kardon Overture performs the further function of overcoming any tendency of the tuner to drift.

In order to take maximum advantage of the benefits of AFC, it is suggested that fine tuning be done with the function switch in the FM position. When the switch is then turned to the FM-AFC position the AFC will improve this careful tuning by a factor of 10 to 1. This procedure is especially recommended in those cases where a weak station is found close to a strong station. Under these conditions, the AFC may tend to reach for the strong station, and completely skip over the weak station. If the weak station is tuned with the AFC defeated, the AFC will lock it in, after it has been reinserted.

MAINTENANCE AND REPAIR

In some installations, hum may be encountered due to a voltage difference between the amplifier, tuner and record changer chassis. This may be eliminated by reversing one or all of the AC power plugs. Simply reverse one at a time until improvement is experienced.

Due to the conservative design and high quality components of the Overture, no routine maintenance other than yearly tube-testing is required. Should trouble develop, however, only the most qualified serviceman should be employed, as special equipment and training is required to properly service high fidelity equipment.

When changing tubes or performing repairs it is necessary to remove the cage and the safety interlock power cord. Do not use a "cheater" cord when the cage is removed as dangerous voltages will then be exposed.

This instruction booklet contains diagrams and other information needed by your repairman. It should be kept available for his use.

LIST OF REPLACEABLE PARTS

DESCRIPTION	HARMAN-KARDON PART NO.	LIST PRICE
Antenna Loopstick	GL781479A	3.45
Loopstick Tuning Ring	P481329A	.25
Function Switch	ER781480C	4.50
Glass Dial Assy	P781415C	1.20
Pointer	Z781482A	.45
Power Transformer	FT781419B	8.40
Variable Condenser	JV781468D	9.45
Electrolytic Capacitor 40-60-60/150 V.	JE781436C	3.75
FM IF Transformer	GT781491A	2.40
FM Disc. Transformer	GT781492A	3.00
AM IF Transformer	GT781493A	2.25
Osc. Trimmer 1-10 mmf.	JV20688	.45
Cage	P781414C	9.00
Knob	P351043	.25
Knob, Tuning	P20778	.25
Instruction Sheet	L781498A	.75
Mounting Template	L781499A	.15

SPECIFICATIONS

RF SECTION

Circuits: FM: Armstrong circuit with Limiter & Foster-Seeley Discriminator. Automatic Frequency Control—Low Noise Front End consisting of Tuned Triode Grounded Grid Amplifier and Triode Mixer.
AM: Superheterodyne with A.V.C. and Ferrite Antenna.
Sensitivity: FM: 5 microvolts for 30 db quieting; 3 microvolts for 20 db quieting. AM: Loop sensitivity 80 microvolts/meter; Terminal sensitivity 20 microvolts.
Selectivity: FM: 200 KC bandwidth: 6 db down. AM: 8 KC bandwidth: 6 db down.
 FM Discriminator peak to peak separation 375 KC.
Frequency Range: FM: 88-108 MC. AM: 530-1650 KC.
FM Drift: ± 5 KC max.
Image Rejection: FM: 40 db. AM: 30 db.
IF Rejection: FM: 70 db. AM: 30 db.
Antenna Input: FM: 300 ohms. AM: Built-in low noise ferrite loopstick plus high impedance terminal for external antenna.
Distortion: Less than 1% harmonic on FM. Less than 1% harmonic for up to 80% mod. on AM.
Frequency Response: FM: ± 1/2 db to 20,000 c.p.s. including standard 75 micro-second deemphasis.
Radiation: Within FCC Requirements.
AM: 3 db to 5,000 c.p.s.
Hum Level: 60 db below 100% modulation.

AUDIO SECTION

Output Level: FM: 2-1/2 volts for 100% modulation; 1 volt for 30% modulation. AM: 1 volt (average).
Output Impedance: High impedance.

WARRANTY

We warrant each Overture, Model T-10 to be free from defects in material and workmanship under normal use and service, and in accordance with the conditions herein below set forth, for a period of 90 days from date of delivery to the original purchaser, and agree to replace or repair any part or parts returned to us within said 90 days, with transportation prepaid, and which our examination shall disclose to our satisfaction to have been thus defective. This warranty does not include free labor, nor is it applicable to any instrument which shall have been repaired or altered in any way so as in our judgment to affect its stability or reliability nor which has been subject to neglect, misuse, abuse, negligence or accident nor which has had the serial number altered, effaced, or removed. Neither shall this warranty apply to any instrument which has been connected otherwise than in accordance with the instructions furnished by us.

This warranty is expressly in lieu of all other warranties, express or implied, and of all other obligations or liabilities on our part, and we neither assume nor authorize any representative or other person to assume for us any other liability in connection with the sale of the Model T-10 Overture.

OVERALL SPECIFICATIONS

Controls: (Total 2) Function (OFF, FM-AFC, FM, AM)
Tube Complements: (Total: 7) 2-12AT7, 1-6BE6, 1-6BA6, 2-6AU6, 1-6AL5, Selenium Rectifier.
Dimensions: 12-1/2" wide x 4" high x 9" deep (including ferrite loopstick—not including knobs).
Power Consumption: 30 watts
Shipping Weight: 10 lbs.
Finish: Escutcheon: brushed copper. Cage: matt black. Edge lighted dial glass: Soft green.
Functional Feature: Counterweighted Tuning Control.

SPECIAL NOTES

- Safety Interlock Power Cord disconnects power when cage is removed.
- Printed circuit used throughout, employs dip soldered copper-clad laminated phenolic plastic board.
- Simple mechanical disassembly makes board easily available for service.
- Face up mounting of T-10 permissible without special precaution.

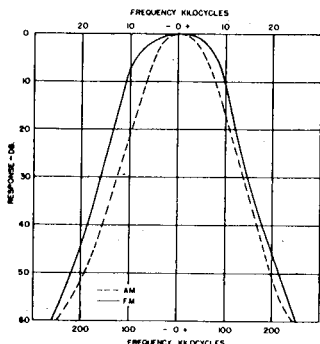

AM and FM selectivity characteristics

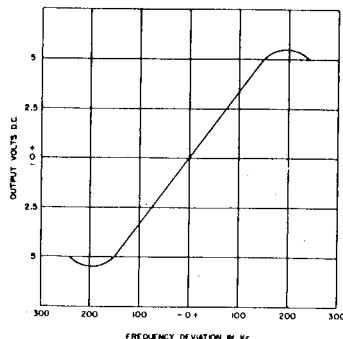

FM discriminator characteristics

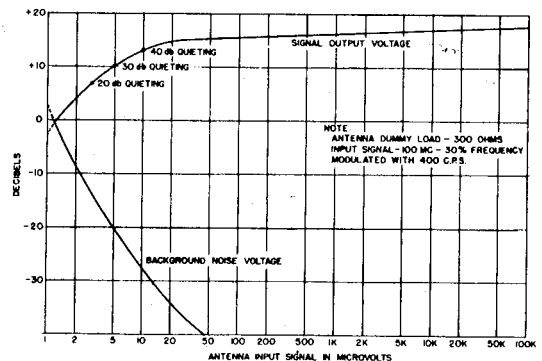

FM detector output voltage characteristics